

Article number: 03506045

Description: Fluro Rod end GE 45FO-2RS

Measures

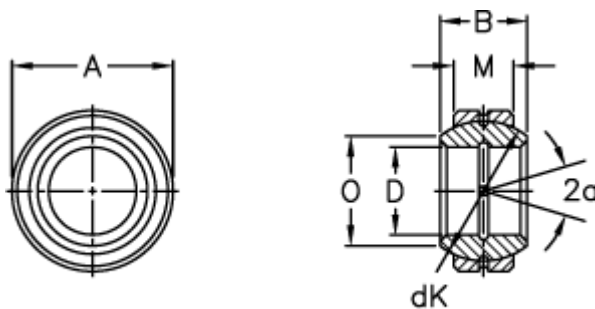

Str. 6–12 uden smørerille

A	= 75 0 -0,013	Tilt angle = 15
B	= 43	Weight = 680
D	= 45 0 -0,012	
dK	= 66	
Dynamic load C (kN)	= 156	
M	= 28	
O	= 50	
Static load C0 (kN)	= 780	